

LEDVANCE.LAT



LEDVANCE

# LÍNEA DE PRODUCTOS LEDVANCE 2024





# CONOZCA LEDVANCE

Somos especialistas en iluminación en todo el mundo.  
Nos encontramos en más de 140 países.

Nuestro equipo de expertos propone a nuestros clientes  
soluciones para satisfacer sus necesidades.

Ofrecemos soluciones innovadoras para aumentar la productividad,  
promover la salud y el bienestar de las personas.

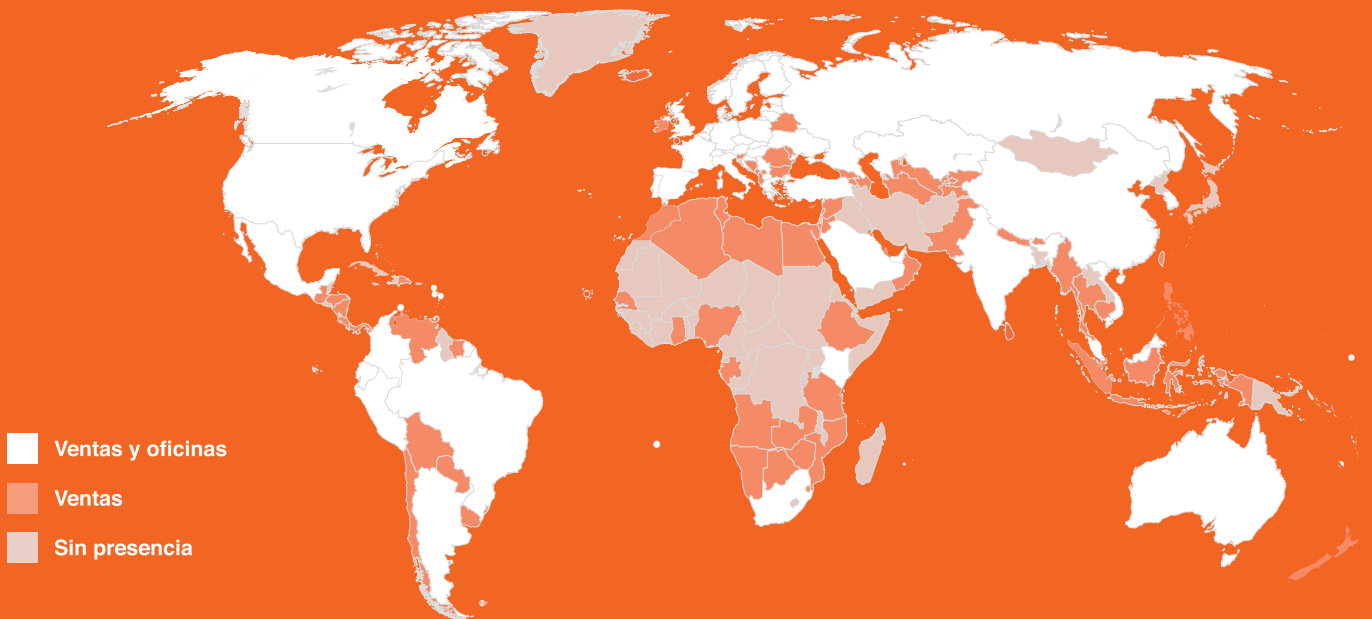

## ARQUITECTURA DE MARCAS

EMPRESA:  **LEDVANCE**

Licencia de producto OSRAM  
en iluminación general

MARCAS:  **LEDVANCE**

**OSRAM** 

PRODUCTOS: 

Luminarias LED  
y productos innovadores



Lámparas tradicionales  
y lámparas LED

## CONOZCA LEDVANCE

Somos uno de los principales proveedores de iluminación del mundo para profesionales y consumidores finales.

LEDVANCE ha surgido del negocio de iluminación de OSRAM y ofrece una amplia gama de luminarias LED para diversas áreas de aplicación, uno de los mayores portafolios de lámparas LED del sector, además de productos para la iluminación tradicional.

## SOMOS LEDVANCE

Nuestro nombre combina el origen de la compañía con una intención para el futuro.

**LED** se refiere a nuestro principal negocio y expresa la creciente importancia de los productos LED en nuestra compañía.

**ADVANCE** se refiere a nuestra ambición e intención de avanzar con la luz.

El logotipo LEDVANCE representa un pulso de luz, que ilustra el avance y el dinamismo de la empresa.

## LÁMPARAS OSRAM

Derivado a un acuerdo con OSRAM, LEDVANCE seguirá comercializando la marca OSRAM para la línea de lámparas tradicionales y LED.

Más información se puede encontrar en el sitio:  
[www.ledvance.lat](http://www.ledvance.lat)

VER VÍDEOS  
DE INSTALACIÓN



# SEGMENTACIÓN DE PRODUCTOS

Encuentre el producto que mejor se adapte a sus necesidades a través de nuestro Sistema de Segmentación de Productos. Los empaques están segmentados por colores que clasifican los productos según su especificación técnica, así:



## CLASES DE SEGMENTACIÓN



El empaque de productos residenciales es oscuro, para mayor protagonismo en el punto de venta, para productos comerciales, blanco, y productos industriales, marrón.



### PERFORMANCE CLASS

La línea de productos PERFORMANCE CLASS está compuesta por productos de alto rendimiento y calidad de LEDVANCE. Para cumplir proyectos de alto nivel.

### VALUE CLASS

Ofrece una familia de productos de alta calidad a un precio atractivo. Aquí puedes encontrar productos para proyectos residenciales y comerciales.

### ECO CLASS

Ofrece una familia de productos con funcionalidad básica para aquellos que buscan soluciones simples, donde el precio es el factor más importante.

# ÍNDICE

## ILUMINACIÓN INTELIGENTE 07

ILUMINACIÓN INTELIGENTE SMART+WIFI	08
------------------------------------	----

## LUMINARIAS LED 10

LUMINARIAS RESIDENCIALES	11
LUMINARIAS CORPORATIVAS	12
APLIQUES	16
LUMINARIAS DE JARDÍN	17
SOLAR	17
PROYECTORES LED	18
ALUMBRADO PÚBLICO	20
LUMINARIAS HERMÉTICAS	21
LUMINARIAS HIGHBAY	22

## TIRAS LED, PERFILES, DRIVERS 25

APLICACIÓN RESIDENCIAL Y COMERCIAL	26
TIRAS LED Y DRIVERS 24V	27

## SENSORES Y FOTOCELDAS 29

## DRIVERS PARA ILUMINACIÓN LED 30



# ILUMINACIÓN INTELIGENTE SMART + WIFI



La línea SMART+WIFI para uso residencial está compuesta por lámparas, luminarias y tiras LED inteligentes, que te permiten tener un control total de la iluminación de tu ambiente: encender, apagar, programar la iluminación, el color, la intensidad de la luz. Todo esto a través de la aplicación LEDVANCE SMART+WIFI, a través de su teléfono inteligente o tableta, e incluso por comando de voz. Para conocer más sobre la línea, acceda al código QR.

ESCANEA AQUÍ



# ILUMINACIÓN INTELIGENTE SMART+ WIFI

## LUMINARIA CEILING SMART+



- ⚡ 22W
- 🌈 RGBW
- 💡 1800lm
- 🕒 15 000 Horas

## LUMINARIA SUSPENDING DECO SMART+



- ⚡ 30W
- 🌈 Tunnable White
- 💡 2300lm
- 🕒 50 000 Horas

## LUMINARIA DOWNLIGHT SMART+



- ⚡ 15W
- 🌈 RGB + 2700K | 6500K
- 💡 1200lm
- 🕒 15 000 Horas

## CINTA LED RGBW SMART+



- ⚡ 4.25W/m
- 🌈 RGBW | 2700K - 6500K
- 💡 380lm/m
- 🕒 15 000 Horas

## LUMINARIA FLOOR CORNER SMART+



- ⚡ 14W
- 🌈 RGB
- 💡 200lm
- 🕒 30 000 Horas

## LÁMPARA SMART RGBW + WIFI



- ⚡ 9W
- 🌈 RGBW | 2700K - 6500K
- 💡 800lm
- 🕒 15 000 Horas

## LÁMPARAS VINTAGE RGBW SMART+



- ⚡ 6W
- 🌈 RGBW
- 💡 500lm
- 🕒 15 000 Horas

## SECURITY LIGHT SMART+



VALUE CLASS



- ⚡ 22W
- 🌈 5000K
- 💡 1600lm
- 🕒 50 000 Horas



### LUMINARIA DESIGN PLAFON SMART+



- ⚡ 32W
- 🌈 RGBW
- 💡 2650lm
- 🕒 50 000 Horas



### LUMINARIA CEILING DECO SMART+



- ⚡ 30W
- 🌈 RGB
- 💡 1890lm
- 🕒 50 000 Horas



### LED SMART+ WIFI PAR16



- ⚡ 5W
- 🌈 RGBW | 2700K - 6500K
- 💡 800 lm
- 🕒 15 000 Horas



# LUMINARIAS LED



ESCANEA AQUÍ



La línea de luminarias LEDVANCE está compuesta por productos para uso residencial, corporativo, hostelería, comercios, zonas industriales, así como productos para uso exterior en jardines, zonas públicas, estadios y recintos deportivos. ¿Quieres saber más? Puede acceder a nuestro catálogo de productos LEDVANCE a través del código QR de al lado, para obtener información detallada sobre nuestras luminarias.



## LUMINARIAS RESIDENCIALES

### SLIM DOWNLIGHT



VALUE CLASS



-  6W | 12W | 18W | 24W
-  3000K | 4000K | 6500K
-  420lm | 1920lm
-  25 000 Horas

### SLIM PLAFON



VALUE CLASS



-  12W | 18W | 24W
-  3000K | 6500K
-  900lm | 1920lm
-  25 000 Horas

### DESKLUM





-  3W
-  TW
-  DIM
-  220lm
-  10 000 Horas

### STRING LIGHT



ECO CLASS



Guirnalda para lámparas LED, para suspender, 7.3m de longitud y 10 boquillas E27.

### PENDULUM INDUSTRIAL & RETRO



ECO CLASS



Luminarias para lámparas LED Vintage, para suspender.

### PENDULUM



ECO CLASS







Versión en negro y bronce.

# LUMINARIAS CORPORATIVAS

## LINEAR



VALUE CLASS

-  8W | 14W | 20W
-  3000K | 4000K | 6500K
-  800lm | 1400lm | 2000lm
-  30 000 Horas



## MULTILINEAR

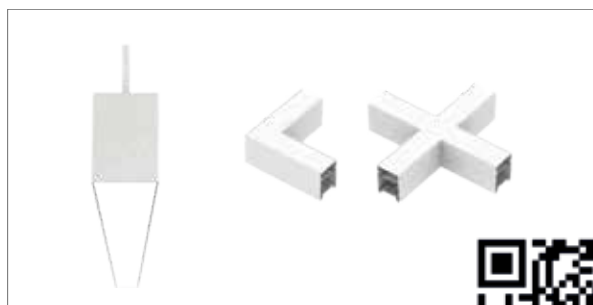

PERFORMANCE CLASS



Luminaria polivalente que puede instalarse de diferentes formas, sola o conectada a otras, creando una iluminación continua sin sombras, 3 temperaturas de color en una luminaria.



## LINEAR PENDANT



VALUE CLASS

-  36W
-  4000K
-  3300lm
-  50 000 Horas



## TRUSYS



PERFORMANCE CLASS

-  35W | 50W
-  4000K
-  5600lm | 8000lm
-  60 000 Horas





Sistema TRUSYS instalado en tienda minorista. Obtenga más información sobre nuestras soluciones en el libro electrónico Retail Lighting.

VER VÍDEO

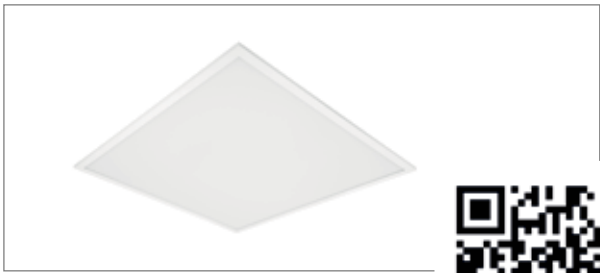

### PANEL PERFORMANCE 600 X 600

⚡ 36W
🌡️ 3000K | 4000K | 5000K | 6500K  
💡 4320lm
🕒 50 000 Horas

### PANEL PERFORMANCE 300 X 1200



⚡ 36W
🌡️ 3000K | 4000K | 6500K  
💡 4320lm
🕒 50 000 Horas

VALUE CLASS

### PANEL PERFORMANCE 600 X 1200



⚡ 54W
🌡️ 3000K | 4000K | 6500K  
💡 6480lm
🕒 50 000 Horas

### ACCESORIOS PARA PANEL GENERACIÓN 5



Accesorios de instalación se venden por separado

### DOWNLIGHT DIM G4



⚡ 20W | 30W | 40W
🌡️ 3000K | 4000K | 6500K  
💡 2300lm | 3400lm | 4100lm
🕒 50 000 Horas

PERFORMANCE CLASS

### DOWNLIGHT RT



⚡ 7W | 43W
🌡️ 2700K | 3000K | 4000K | 5000K  
💡 500lm | 4000lm
🕒 50 000 Horas

PERFORMANCE CLASS

### EMERGENCY LIGHT



⚡ 2.5W
🌡️ 6500K  
💡 200lm
🕒 30 000 Horas

PERFORMANCE CLASS

### LED EMERGENCY



⚡ 2W
🌡️ 6500K  
💡 210lm
🕒 30 000 Horas

VALUE CLASS

### SPOTLIGHT



- 10W
- 3000K | 4000K | 6500K
- 800lm
- 30 000 Horas



### SPOTLIGHT VARIO



- 35W
- 3000K | 4000K
- 3350lm
- 50 000 Horas



### DOWNLIGHT PFM SURFACE IP20



- 20W | 30w | 40w
- 3000K | 4000K
- 2200lm | 3300lm | 4400lm
- 35 000 Horas



### MULTISPOT



ECO CLASS

Luminarias para lámparas PAR30 y AR111. Versiones en blanco y negro.



### SPOTLIGHT MODULAR



PERFORMANCE CLASS

- 13W | 18W
- 3000K | 4000K
- 1200lm | 1700lm
- 50 000 Horas



### ACCESORIOS PARA SPOTLIGHT MODULAR



9 modelos de accesorios compatibles con spotlight modulares, o lámparas PAR16. Versiones en blanco y negro.



## TRACKLIGHT



PERFOR-  
MANCE  
CLASS

Spots para lámparas PAR 16, 20, 30, AR 70 y AR11. Versiones en blanco y negro.



## TRACKLIGHT ZOOM



Con LED integrado, foco ajustable y regulable IRC>97 I DIM

⚡ 28W | 33W | 38W    🔥 3000K | 4000K  
💡 3400lm    ⌚ 50 000 Horas



## ACCESORIOS TRACKLIGHT: CONECTORES



Conectores en diversos formatos, versiones en blanco y negro.



## ACCESORIOS TRACKLIGHT: RIELES



Barandillas de 1m y 2m, empotradas o superpuestas.



Iluminación con  
TRACKLIGHT ZOOM

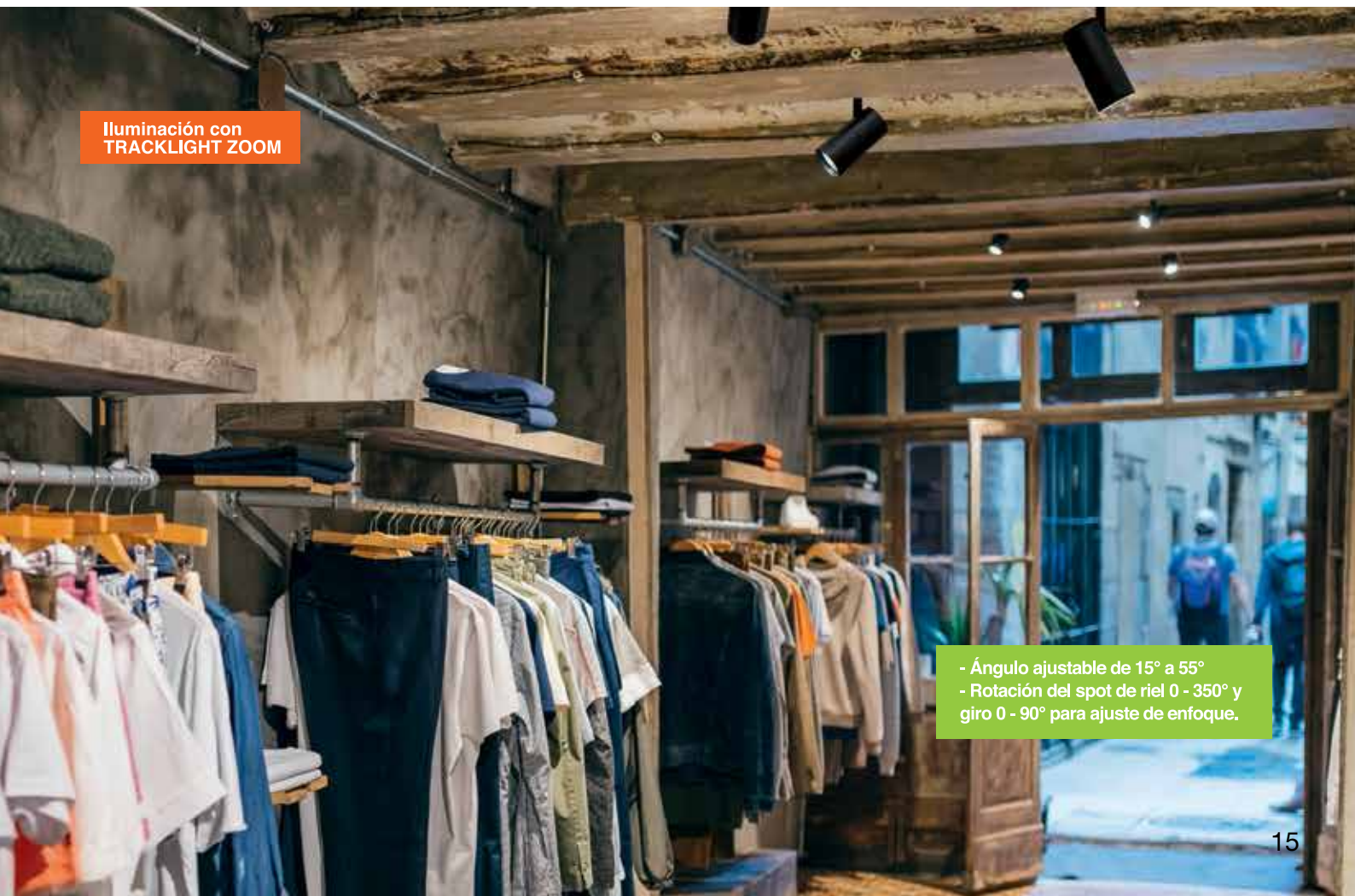

- Ángulo ajustable de 15° a 55°  
- Rotación del spot de riel 0 - 350° y giro 0 - 90° para ajuste de enfoque.



## LUMINARIAS DE JARDÍN

### UPLIGHT



⚡ 6W | 9W | 15W | 24W    🌡️ 3000K | 5000K  
 💡 540lm | 900lm | 1500lm    ⌚ 30 000 Horas  
 | 2400lm

### MULTI OUTDOOR



⚡ 10W    🌡️ 3000K  
 💡 490lm    ⌚ 50 000 Horas

### GARDEN SPIKE



⚡ 5W | 9W    🌡️ 3000K  
 💡 350lm | 720lm    ⌚ 15 000 Horas

### TRICKLIGHT



⚡ 7W    🌡️ 3000K | 4000K  
 💡 560lm    ⌚ 30 000 Horas

### FLOODLIGHT RGB+5000K



⚡ 20W | 40W | 50W    🌡️ RGBW + 5000K  
 💡 2000lm | 4000lm    ⌚ 15 000 Horas  
 | 5000lm



# APLIQUES

## ENDURA STYLE RING



VALUE CLASS



⚡ 13W    🌡️ 3000K    ⬆️ IP44  
💡 500lm    ⌚ 30 000 Horas

## ENDURA COVER RD



VALUE CLASS



⚡ 13W    🌡️ 3000K    ⬆️ IP44  
💡 640lm    ⌚ 30 000 Horas

## ENDURA MINI SPOT I



VALUE CLASS



⚡ 8W | 13W    🌡️ 3000K    ⬆️ IP44  
💡 320lm | 800lm    ⌚ 30 000 Horas

## ENDURA STYLE SQUARE



VALUE CLASS



⚡ 13W    🌡️ 3000K    ⬆️ IP44  
💡 500lm    ⌚ 30 000 Horas

## ENDURA STYLE SHIELD RD



VALUE CLASS



⚡ 11W    🌡️ 3000K    ⬆️ IP44  
💡 400lm    ⌚ 30 000 Horas

## APLIQUE DUAL HOUSING



ECO CLASS



⬆️ IP44    4 formatos con portalámparas GU10 para lámparas PAR16, versiones en blanco y negro.

## BULKHEAD



VALUE CLASS



⚡ 10W | 30W    🌡️ 3000K | 6500K  
⌚ 30 000 Horas    💡 450lm | 900lm  
⬆️ IP65    | 1450lm | 2900lm

## BULKHEAD MID



VALUE CLASS



⚡ 10W | 30W    🌡️ 3000K | 6500K  
⌚ 30 000 Horas    💡 450lm | 900lm  
⬆️ IP65    | 1450lm | 2900lm



## SOLAR

### SOLAR FLOODLIGHT (RESIDENCIAL)



- 5W
- 6500K
- IP65
- 500lm
- 25 000 Horas

### SOLAR WALL (RESIDENCIAL)



- 4W | 8W
- 6500K
- 500 lm | 850lm
- 25 000 Horas

### SOLAR WALL 2



- 4W | 7W
- 6500K
- 400lm | 800lm
- 25 000 Horas

### SOLAR SECURITY (RESIDENCIAL)



- 10W
- 6500K
- 1 000 lm
- 30 000 Horas

### SOLAR STREETLIGHT ECO



- 13W | 24W
- 4000K | 6500K
- 2000lm | 4000lm
- 20 000 Horas

### SOLAR FLOODLIGHT VALUE



- 8W | 15W  
20W | 25W
- 3000K | 4000K  
| 6500K
- 1000lm | 2000lm  
3000lm | 4500lm
- 50 000 Horas

# PROYECTORES LED

## FLOODLIGHT BAJA POTENCIA



PERFORMANCE CLASS

- 10W | 30W | 50W
- 800lm | 2700lm | 4500lm
- 3000K | 5000K
- 30 000 Horas
- IP65



## FLOODLIGHT SENSOR



PERFORMANCE CLASS

- 20W
- 1800lm
- 3000K | 5000K
- 30 000 Horas
- IP65



## FLOODLIGHT MEDIA POTENCIA



PERFORMANCE CLASS

- 80W | 125W | 165W | 200W
- 8800lm | 13750lm | 18150lm | 22000lm
- 3000K | 5000K
- 50 000 Horas



## FLOODLIGHT SIMÉTRICA



PERFORMANCE CLASS

- 72W | 105W | 145W
- 9200lm | 10 000lm | 13750lm | 15000lm | 17400lm
- 3000K | 5000K
- 50 000 Horas



## FLOODLIGHT ALTA POTENCIA



PERFORMANCE CLASS

- 300W | 400W | 600W
- 36000lm | 48000lm | 72000lm
- 5700K
- 50 000 Horas



## FLOODLIGHT ASYM



PERFORMANCE CLASS

- 72 W | 105W | 145W
- 10000lm | 15000lm | 20000lm
- 3000K | 5000K
- 50 000 Horas



Aplicación para exteriores



Ver vídeo del estadio de fútbol de Defensa y Justicia en Argentina, equipado con reflectores FLOODLIGHT 1KW.

VER VÍDEO



### FLOODLIGHT 1KW



-  5700K
-  120 000lm
-  50 000 Horas
-  IP66
-  IK08





Ideal para iluminar estadios y áreas deportivas, brindando una correcta distribución lumínica.

### FLOODLIGHT MAX 600W - 900W - 1200W



PERFORMANCE CLASS



-  600W | 900W | 1200W
-  78000lm | 117000lm | 156000lm
-  5700K
-  100 000 Horas

### FLOODLIGHT MAX 300W



PERFORMANCE CLASS



-  300W
-  39000lm
-  5700K
-  100 000 Horas

### FLOODLIGHT 1.4KW



PERFORMANCE CLASS



-  1400W
-  196000lm
-  5700K
-  75 000 Horas

# LUMINARIAS ARQUITECTONICAS

## FLOODLIGHT RGBW DMX / PWM4



PERFOR-  
MANCE  
CLASS

- ⚡ 36W
- 🌡️ RGB + 3000K
- 💡 2000lm
- 🕒 35 000 Horas



## WALL WASHER RGBW DMX / PWM4



PERFOR-  
MANCE  
CLASS

- ⚡ 18W | 36W
- 🌡️ RGB + 3000K
- 💡 800lm | 1600lm
- 🕒 35 000 Horas



# ALUMBRADO PÚBLICO

## AREALIGHT



ECO CLASS

- ⚡ 50W | 70W
- 🌡️ 4000K | 6500K
- ☀️ 5000lm | 7000lm
- 🕒 50 000 Horas



## AREALIGHT HIGH WATTAGE



ECO CLASS

- ⚡ 90W | 120W | 150W
- 🌡️ 3000K | 4000K | 6500K
- ☀️ 12150lm | 16200lm | 20250lm
- 🕒 50 000 Horas



## URBANA AM



PERFORMANCE CLASS

- ⚡ 50W | 75W | 90W
- 🌡️ 4000K | 5000K
- ☀️ 140 lm/w
- 🕒 100 000 Horas



## SKY STANDAR G3



PERFORMANCE CLASS

- ⚡ 55W | 90W | 120W | 150W | 200W | 230W
- 🌡️ 4000K
- ☀️ 150lm/w
- 🕒 80 000 Horas



## SKY PROFESSIONAL CII 10Y



PERFORMANCE CLASS

- ⚡ 30W | 55W | 90W | 120W | 180W | 200W | 230W | 300W
- 🌡️ 4000K
- ☀️ 145lm/w
- 🕒 100 000 Horas



## SOLAR STREETLIGHT G2



PERFORMANCE CLASS

- ⚡ 25W | 45W | 60W | 100W
- 🌡️ 4000K | 5000K
- ☀️ 4625lm | 8325lm | 11100lm | 18500lm
- 🕒 60 000 Horas



# LUMINARIAS HERMÉTICAS

## DAMP-PROOF LED



PERFORMANCE CLASS

⚡ 18W | 36W | 58W    🔥 3000K | 4000K | 6500K  
 ☀️ 2340lm | 4680lm    ⌚ 50 000 Horas | 7540lm



## DAMP-PROOF SLIM



⚡ 18W | 36W | 48W    🔥 4000K | 6500K  
 ☀️ 1980lm | 3960lm    ⌚ 20 000 Horas | 5280lm



## DAMP-PROOF SENSOR



PERFORMANCE CLASS

⚡ 36W    🔥 4000K | 6500K  
 ☀️ 4320lm    ⌚ 50 000 Horas



## DAMP-PROOF HOUSING



PERFORMANCE CLASS

Luminaria hermética para tubos LED T5 y T8 socket G5-G13. Incluye soporte para tubos.



## DAMP-PROOF EMERGENCY DRIVER



PERFORMANCE CLASS

⚡ 38W | 60W    🔥 4000K | 6500K  
 ☀️ 4940lm | 7800lm    ⌚ 50 000 Horas



## DP COMPACT IP66



PERFORMANCE CLASS

⚡ 44W | 55W    🔥 6500K  
 ☀️ 5400lm | 6700lm    ⌚ 50 000 Horas







# LUMINARIAS HIGHBAY

## HIGHBAY VALUE



VALUE  
GLASS





-  125W | 150W | 200W
-  4000K | 6500K
-  15000lm | 18000lm | 24000lm
-  30 000 Horas



## HIGHBAY PFM G4



PERFOR-  
MANCE  
CLASS

-  90W | 120W | 150W | 200W
-  4000K | 5700K | 6500 K
-  14400lm | 19200lm | 24000lm | 32000lm
-  50 000 Horas



## HIGHBAY PFM SELECTABLE



PERFOR-  
MANCE  
CLASS





-  150W | 200W | 240W
-  4000K | 5000K | 6500K
-  170lm/W
-  50 000 Horas



## HIGHBAY PREMIER





PERFOR-  
MANCE  
CLASS

-  95W | 140W | 190W | 240W
-  4000K | 5000K | 6500K
-  15200lm | 22400lm | 30400lm | 38400lm
-  50 000 Horas



## HIGHBAY NSF



-  150W | 200W
-  5000K
-  21000lm | 28000lm
-  50 000 Horas
-  IP69







Conta con certificación NSF (National Sanitation Foundation)

## CANOPY



PERFOR-  
MANCE  
CLASS

-  100W | 150W
-  5700K
-  15000lm | 22500lm
-  50 000 Horas





# TIRAS LED, MÓDULOS DRIVERS Y ACCESORIOS

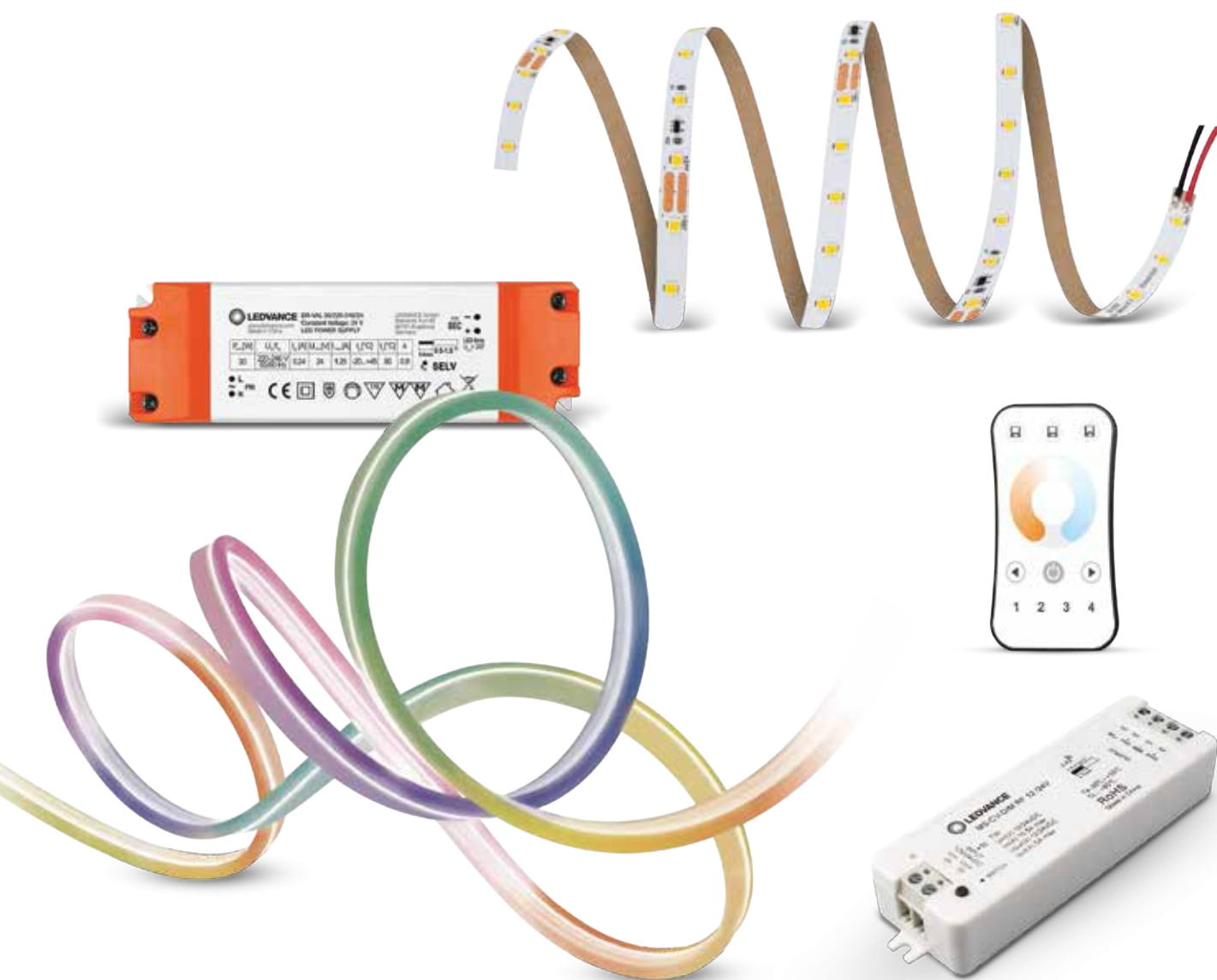

Este portafolio se compone de tiras LED, drivers y accesorios (cable de alimentación, conectores, clips de fijación, controladores, control remoto). Abarca desde productos PLUG 8 USE, para uso residencial, hasta cintas profesionales, en 24V. Para aplicaciones decorativas o como iluminación principal, están disponibles en diferentes tonos de color, entre RGBW y blanco dinámico.

Para conocer más sobre la línea, accede al código QR.



# TIRAS LED Y DRIVERS: APLICACIÓN RESIDENCIAL Y COMERCIAL

## ECOFLEX 12V USO INTERNO IP20



VALUE CLASS

- 5W/m | 100W/m
- 575lm/w | 1000lm/w
- 5 metros
- 2700K | 3000K  
4000K | 6500K
- 30 000 Horas



## ECOFLEX 12V USO INTERNO IP65



VALUE CLASS

- 5W/m | 10W/m
- 550lm/m | 1000lm/m
- 5 metros
- 2700K | 4000K  
| 6500K
- 30 000 Horas



## DRIVERS ECOFLEX 12V



- 30W | 60W
- 20 000 Horas

Versiones IP20 para uso interno y IP67 para uso externo.



## ECOKIT USO INTERNO



VALUE CLASS

- 4.8W/m
- 400lm/m
- 2700K | 4000K | 6500K
- 20 000 Horas

Kit Plug&Play con 5 m de tira LED IP20 + plug para la conexión a la red eléctrica.



## TIRA 5V ECOFLEX USB



ECO CLASS

- 2.5W/m
- 40lm/m RGB
- 25 000 Horas

2m de tira LED de luz blanca y colorida con conexión USB. Control remoto incluido.





## TIRA LED PRIME FLEX 24V

### PRIME FLEX 24V LED COB



PERFORMANCE CLASS





-  38W
-  55000lm
-  2700K, 4000K
-  50 000 Horas



### PRIME FLEX 24V USO INTERNO



PERFORMANCE CLASS





-  9.6W/m | 12W/m | 16.8W/m | 19.2W/m
-  1300lm | 1650lm | 1950lm | 2400lm
-  IP20
-  2700K | 4000K
-  50 000 Horas
-  5 metros



### PRIME FLEX 24V USO EXTERNO



PERFORMANCE CLASS

-  9.6W/m | 12W/m | 16.8W/m | 19.2W/m
-  1300lm | 1650lm | 1950lm | 2400lm
-  IP66
-  2700K, 4000K
-  50 000 Horas



### DRIVER PRIME FLEX



-  100W
-  50 000 Horas

Calidad superior y larga durabilidad. Versiones para uso interno (IP20) y uso externo (IP67).







### TIRA LED RGB Y BLANCO DINÁMICO



-  14.4 W/m
-  RGB
-  360-440 lm/M
-  40 000 Horas
-  340-420 lm/M

### VALUE FLEX 24V USO INTERNO









-  6.1W/m
-  3000K | 4000K | 6500K
-  610lm
-  20 000 Horas
-  50 metros

### TIRA LED NEON RGBW Y BLANCO DINÁMICO



PERFORMANCE CLASS



-  14.4 W/m
-  RGBW
-  360-440 lm/M
-  50 000 Horas
-  340-420 lm/M
-  5 metros

### ACCESORIOS TIRA LED RGB, RGBW, TW Y NEON



Accesorios, mando a distancia y controladores para cinta RGB, RGBW y TW.

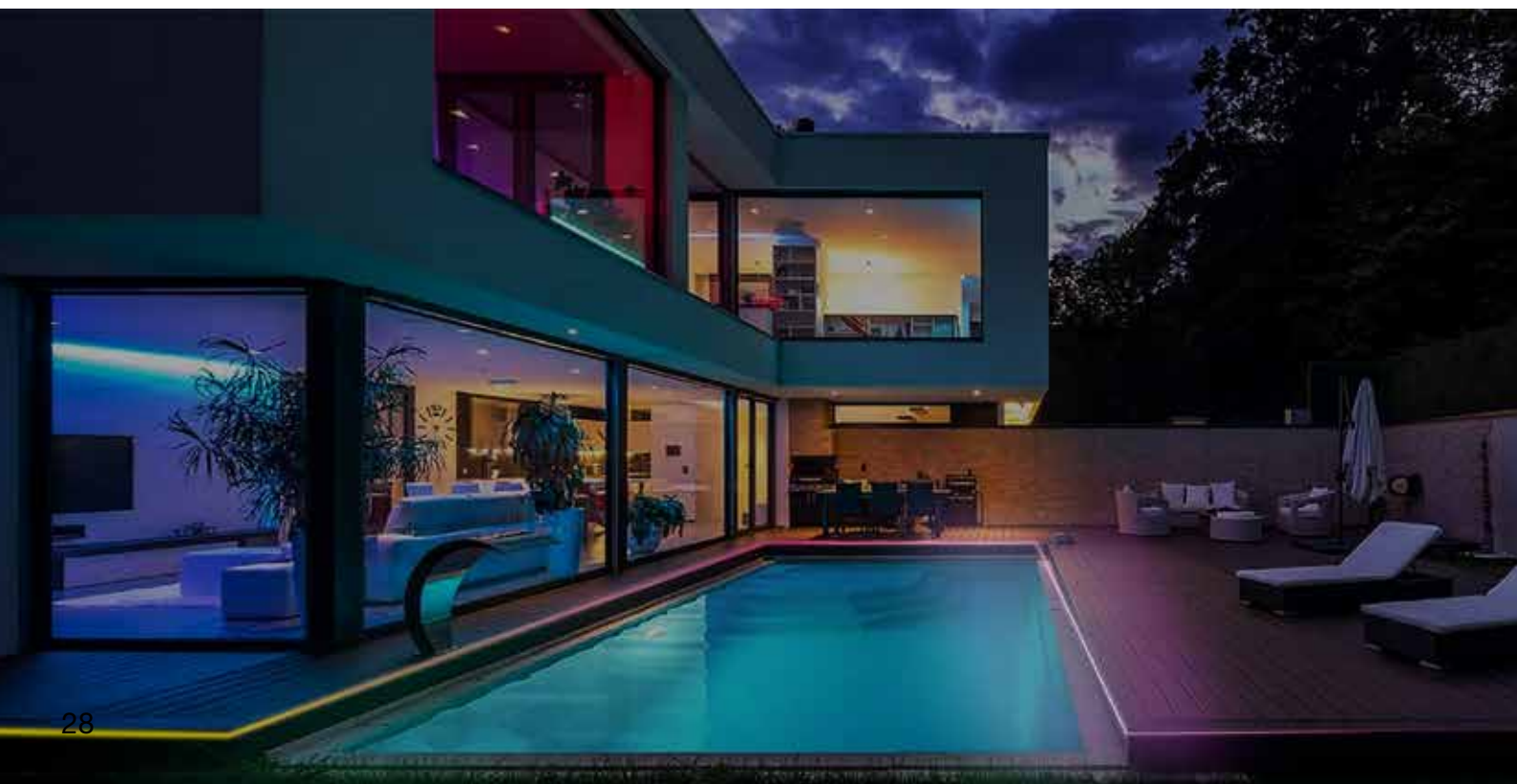

# SENSORES Y FOTOCELSDAS

## SENSOR INDUSTRIAL

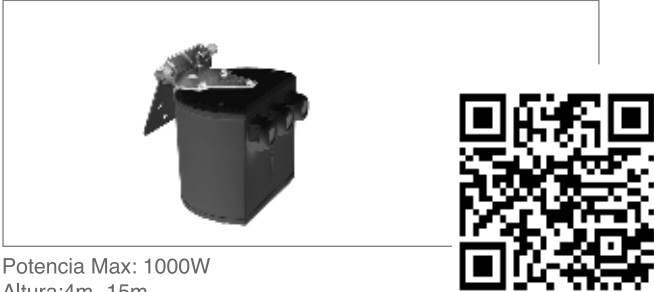

Potencia Max: 1000W  
 Altura: 4m -15m  
 Área de detección: 360°  
 Sensor de movimiento e luminosidad. Uso externo (IP65)

## SENSOR INFRARROJO 360° USO INTERIOR



Sensores infrarrojos con activación de movimiento y temporizador. Versiones superpuestas y empotradas.

## SENSOR INFRARROJO 180° USO EXTERIOR



Sensores infrarrojos con activación de movimiento y temporizador. Versiones con giro vertical y horizontal/vertical.

## SENSOR DE MOVIMIENTO INFRARROJO



Sensores infrarrojos con activación de movimiento y temporizador. Versiones superpuestas y empotradas.

## SENSOR MICROWAVE EMPOTRABLE INTERIOR



Sensores infrarrojos con activación de movimiento y temporizador. Versiones superpuestas y empotradas.

## SENSOR INFRARROJO EMPOTRABLE INTERIOR



Sensores infrarrojos con activación de movimiento y temporizador. Versiones superpuestas y empotradas.

## SENSOR INFRARROJO PARED USO INTERIOR



Sensores infrarrojos con activación de movimiento y temporizador. Versiones superpuestas y empotradas.

## SENSOR INFRARROJO 180° USO EXTERIOR



Sensores infrarrojos con activación de movimiento y temporizador. Versiones superpuestas y empotradas.

# DRIVERS PARA LUMINARIAS Y MÓDULOS

## DRIVER CORRIENTE CONSTANTE DALI Y PUSH DIM



⚡ 26W | 44W

Diferentes disponible en 3 versiones de potencia y corriente regulable por dip-switch. Versión DALI.

## DRIVER CORRIENTE SELECCIONABLE



⚡ 23W | 40W | 56W

Driver disponible en 3 versiones de potencia y salida de corriente, regulable por dip-switch.

## DRIVERS NFC TAPTRONIC



Driver corriente constante, programable por NFC, dimerizable 0-10V.



# MÓDULOS LED PARA LUMINARIAS

## MÓDULO PFM 560mm

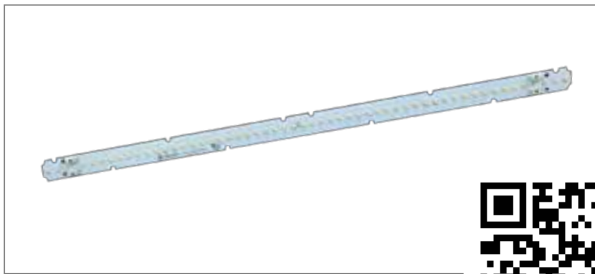

Módulo lineal LED de alto flujo luminoso, ideal para luminarias y perfiles.



## MÓDULO BREAKABLE 1167mm

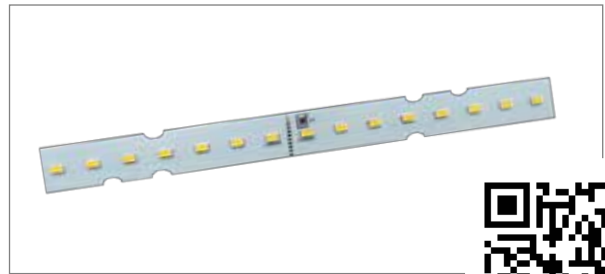

Módulo lineal LED de alto flujo tipo breakable, ideal para ensamble de luminarias Lowbay y Highbay.



## MÓDULO TROFFER 1117mm



Módulo lineal LED de alto flujo, tipo breakable, ideal para ensamble de luminarias y perfiles.



## MÓDULO SPOT 111 PRO



Módulo circular con tecnología a COB de alta eficiencia, para reemplazo de luminarias R111, disponible en ángulos de luz 24D, 40D y 60D.

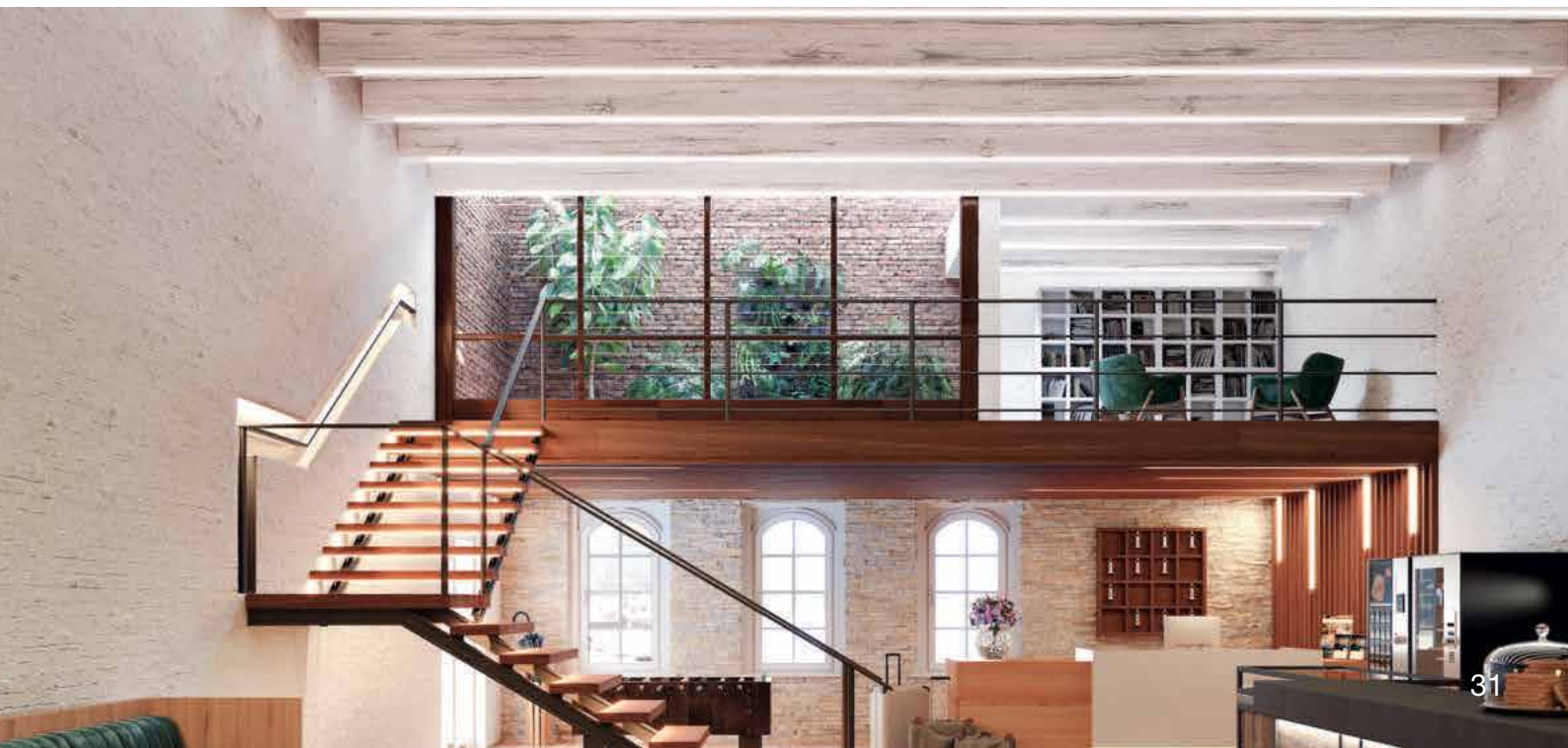





---

# NOTAS

---

---

---

---

---

---

---

---

---

---

---

---

---

---

---

---

---

---

---

---

---

---

---

---

---

---

---

---

---

---







# LEDVANCE

## SOBRE LEDVANCE

Con oficinas en más de 50 países y negocios en más de 140 países, LEDVANCE es uno de los principales proveedores mundiales de iluminación general para profesionales y consumidores finales. Surgió del portafolio de iluminación clásica del gigante alemán OSRAM, y ofrece un amplio portafolio de luminarias LED para las más diversas aplicaciones, productos inteligentes enchufables y lámparas LED para el segmento industrial y tradicional.

### LEDVANCE ANDINA

#### LEDVANCE ECUADOR

Salida norte del Aeropuerto José Joaquín de Olmedo  
Al lado del Hotel Holiday Inn  
Edificio SKY BUILDING piso 6 of. 601 - 602  
☎ + (593) (4) 5002380  
✉ info-ec@ledvance.com  
Guayaquil - Ecuador

#### LEDVANCE PERÚ

Rivera Navarrete 395 Torre Tower - Oficina 1402  
☎ +51 912 274 842  
✉ info-pe@ledvance.com  
☎ (01) 618 5800  
Lima - Perú

#### LEDVANCE COLOMBIA

Carrera 11 A # 94 A - 31 Of. 407  
☎ +57 601 721 8785  
ZIP Code: 110221  
✉ info-co@ledvance.com  
Bogotá - Colombia

[www.ledvance.lat](http://www.ledvance.lat)



## LEDVANCE.LAT

SÍGUENOS EN REDES SOCIALES  
@LedvanceEcuador



Licencia de producto OSRAM  
en lámparas e iluminación general

